

Closets

Pull-Down Closet Rod

- Kitchens
- Doors
- Kitchen Accessories
- Hinges
- Drawer Slides
- Plywood Melamine
- Veneer Edgebanding
- Laminate
- Solid Surface



- Allows Convenient Access To Clothing At Any Height
- Available In 3 Sizes
- Each Size Is Adjustable In Width
- 44 Lb. Weight Rating



ORDER NUMBER	FINISH / SIZE
43-346	600 - 850 (23 5/8" - 33 7/16")
43-348	850 - 1100 (33 7/16" - 43 1/8")
43-350	Aluminum - 32 11/16" - 47 1/4"
43-352	Nickel/Black - 32 11/16" - 47 1/4"
43-354	Black - 32 11/16" - 47 1/4"
43-356	Aluminum - 23 5/8" - 32 11/16"
43-358	Nickel/Black - 23 5/8" - 32 11/16"
43-360	Black - 23 5/8" - 32 11/16"
43-362	Aluminum - 17 3/4" - 23 5/8"
43-364	Nickel/Black - 17 3/4" - 23 5/8"
43-366	Black - 17 3/4" - 23 5/8"

Closets

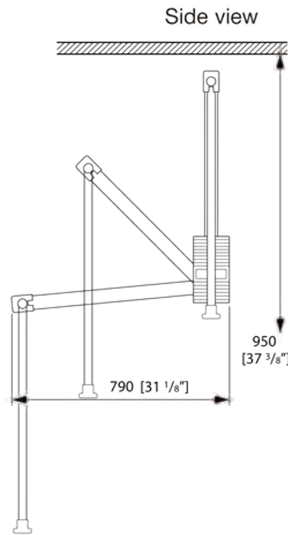
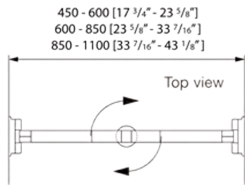

- Furniture Hardware
- Pulls & Knobs
- Lighting
- Grommets
- Locks, Lock Systems
- Molding, Carvings
- Tools

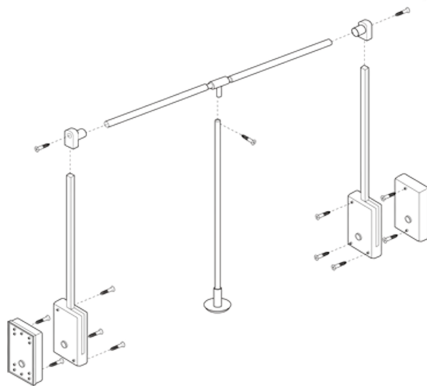

CHROME 5MM HANGING PEG

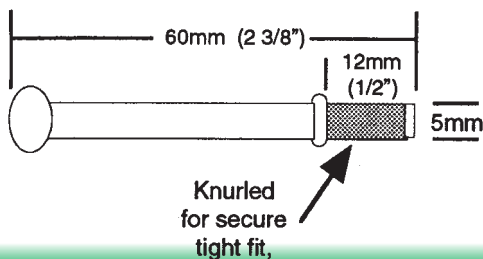

Unlimited uses such as hanging purses, ties, belts, etc.
 Fits 5mm hole - Chrome finish
Order Number 43-850

Most of the merchandise in this catalog is available in all Hardware Imagination-Tech locations. If your selection isn't available at the store nearest you, we'll gladly order it from one of the other stores or through special order.

Closets

VALLET ROD AND HANGER

12" Chrome Plated Valet Rod 5023
Also available in satin chrome and brass
Order Number 43-384



Chrome Plated Hanger
Order Number

43-384Chrome
43-385Brass

BELT RACK



Item No.	Content	Body Size	For External
		(W x D x H)	Carcase Width
46-112	1 Belt Rack	3 1/2" x 18" x 3 1/2"	6"
46-114	1 Belt Rack	3 1/2" x 14" x 3 1/2"	6"

PANT HOLDER



Top Mount Full Extension

Item No.	Content	Body Size	For External
		(W x D x H)	Carcase Width
46-106	1 Pants Rack	13" x 18" x 4"	20"



Side Mount Rack

Item No.	Content	Body Size	For External
		(W x D x H)	Carcase Width
46-102	1 Right Side Mount Rack	13" x 20" x 4"	15"
46-104	1 Left Side Mount Rack	13" x 20" x 4"	15"

TIE & BELT RACK



Item No.	Content	Body Size	For External
		(W x D x H)	Carcase Width
46-108	1 Tie Rack	3 1/2" x 18" x 3 1/2"	6"

BELT RACK

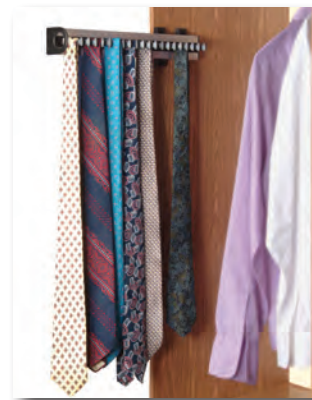

Item No.	Content	Body Size	For External
		(W x D x H)	Carcase Width
46-110	1 Tie & Belt Rack	3 1/2" x 18" x 3 1/2"	6"

Kitchens

Doors

Kitchen
Accessories

Hinges

Drawer
Slides

Plywood
Melamine

Veneer
Edgebanding

Laminate

Solid
Surface

Closets

Furniture
Hardware

Pulls
&
Knobs

Lighting

Grommets

Locks,
Lock
Systems

Molding,
Carvings

Tools

Adhesives
Solvents
Abrasives

Chemicals
Staples
Screws

Suspension Brackets

Kitchens

Doors

Kitchen Accessories

Hinges

Drawer Slides

Plywood Melamine

Veneer Edgebanding

Laminate

Solid Surface

Closets

Furniture Hardware

Pulls & Knobs

Lighting

Grommets

Locks, Lock Systems

Molding, Carvings

Tools

Adhesives Solvents Abrasives

Chemicals Staples Screws

Suspension Rail:

Suspension Rail will make quick work of any installation. The unique hole pattern allows the installer to quickly locate all of the stud locations.



Order Number	Description	Length	Material/Color
19-210	Suspension Rail	8'	Steel
19-219	Rail Cover	8'	Almond
19-206	Rail Cover	8'	Brown
19-217	Rail Cover	8'	White

Description:

- Self-Centering Suspension Rail - 16" Center To Center
- Hole Pattern Repeats Itself For A Quick Installment
- Rail Cover Available In 7 Colors

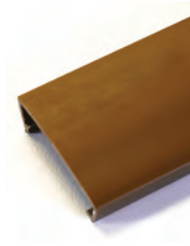

BROWN



ALMOND



WHITE

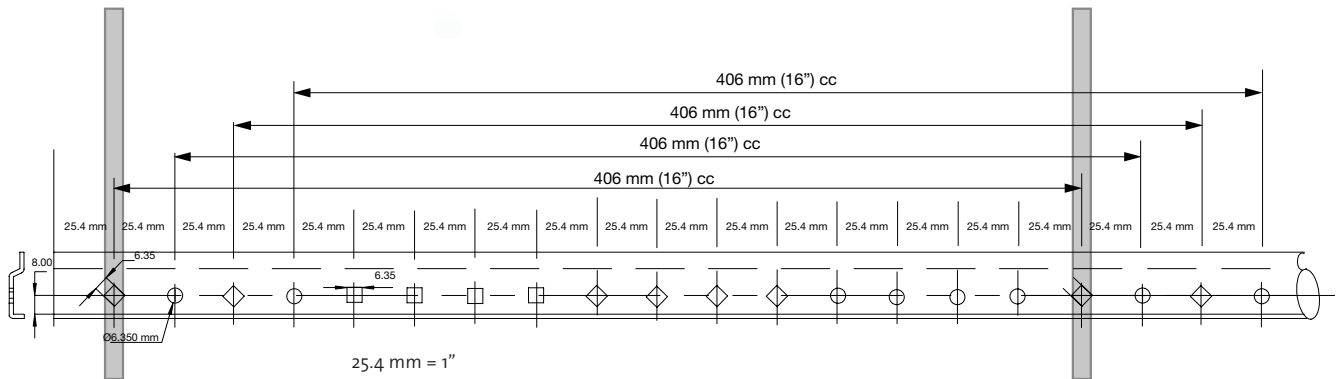

Simply find the first stud, identify the hole, there will be a stud every time the pattern repeats.

Closets

Suspension Brackets

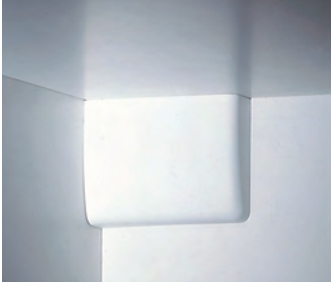

Description:

- All Metal
- 286 Lbs. Carrying Capacity Per Wall Cabinet



Description	Color	Left	Right
Suspension Bracket	Steel	19-212	19-214
Bracket with Cover Cap	White	19-211	19-215
Bracket with Cover Cap	Almond	19-213	19-216
Bracket with Cover Cap	Brown	19-207	19-209



Kitchens

Doors

Kitchen Accessories

Hinges

Drawer Slides

Plywood Melamine

Veneer Edgebanding

Laminate

Solid Surface

BRIDGE SUPPORT

Description:

- I-beam design provides superior support for 3/4" shelving
- Available in 14" and 16" lengths
- Both lengths are easily cut to size

Bridge Support (90° Corner Bracket)

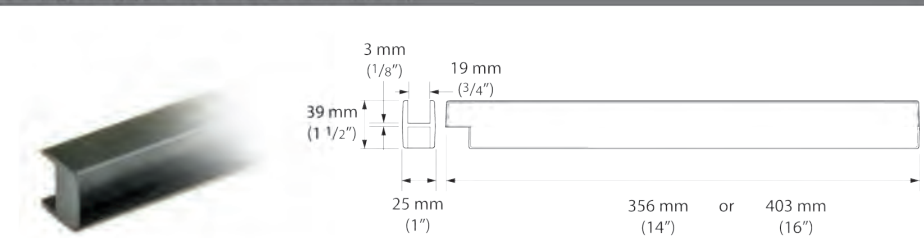

Description	14"	16"
White	19-240	19-241
Almond	19-242	19-243
Candlelight	19-244	19-245
Warm Cherry	19-246	19-247
Brown	19-248	19-249

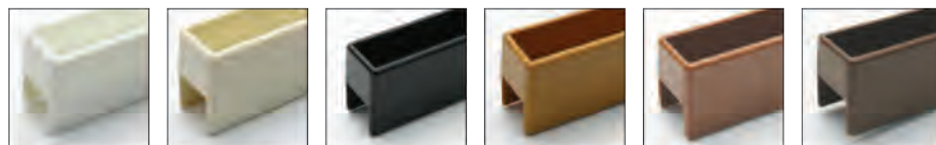

White Almond Black Candlelight Warm Cherry Brown

Closets

Furniture Hardware

Pulls & Knobs

Lighting

Grommets

Locks, Lock Systems

Molding, Carvings

Tools

Adhesives Solvents Abrasives

Chemicals Staples Screws



Cam and Dowel Fittings

Description:

- All Metal Or Metal/Plastic
- Strong Vibration-Proof Connection
- For 16 mm And 19 mm Material

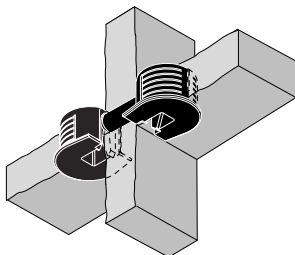
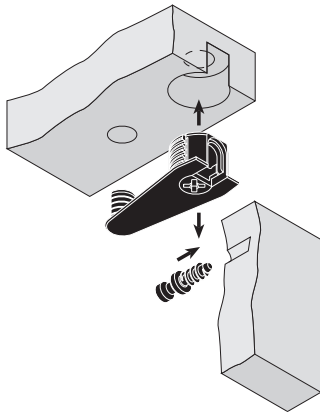

Outtrigger - 19 mm (3/4")

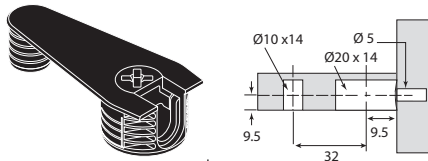

Order Number	Description
19-280	White
19-281	Almond
19-282	Brown
19-283	Black



Non-outtrigger - 19 mm (3/4")

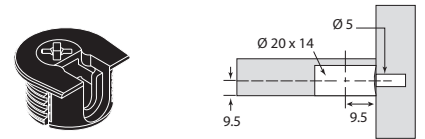

Order Number	Description
19-270	White
19-271	Almond
19-272	Brown
19-273	Black
19-274	Zinc

Outtrigger - 16 mm (5/8")

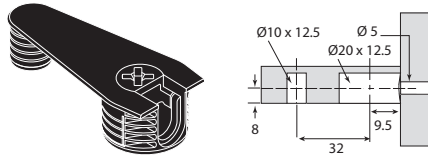

Order Number	Description
19-283	White
19-285	Almond
19-286	Brown
19-287	Black

Non-outtrigger - 16 mm (5/8")

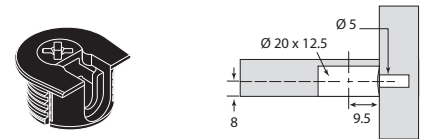

Order Number	Description
19-275	White
19-276	Almond
19-277	Brown
19-278	Black

Connecting Dowel Fittings



Order Number	Description
19-221	5mm X 12mm

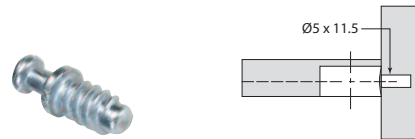

Order Number	Description
19-222	5mm X 11.5mm

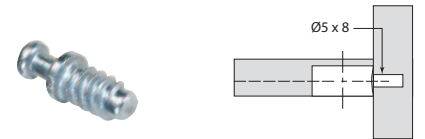

Order Number	Description
19-224	5mm X 8mm

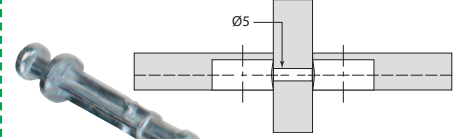

Order Number	Description
19-225	Double Dowel 5mm

Kitchens

Doors

Kitchen Accessories

Hinges

Drawer Slides

Plywood Melamine

Veneer Edgebanding

Laminate

Solid Surface

Closets

Furniture Hardware

Pulls & Knobs

Lighting

Grommets

Locks, Lock Systems

Molding, Carvings

Tools

Adhesives Solvents Abrasives

Chemicals Staples Screws

Cam and Dowel Fittings

Description:

- For 16 mm And 19 mm Material
- Mechanical Lock
- Resists Loosening After Installation

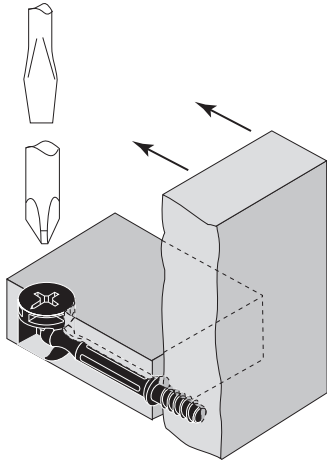

- Special Locking Feature Provides A Strong, Vibration-Proof Joint.
- Quickfit T12 Dowel Allows The Greatest Tolerance In The Market: $-1/+3$ mm
- Choose From 3 Dowel Types.
- Suitable For Use With $\varnothing 5$, $\varnothing 8$ And $\varnothing 10$ mm Panel To Panel Applications.

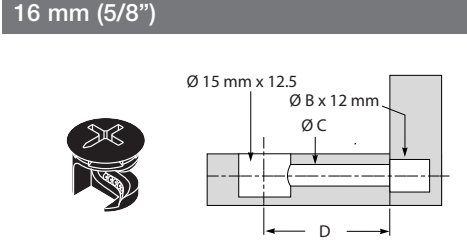
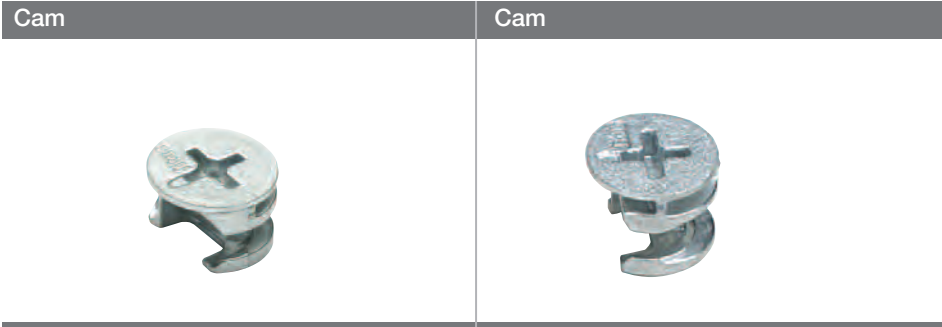

For 5/8" Panels
16mm Panel Thickness
ORDER NUMBER
Zinc Finish 19-230

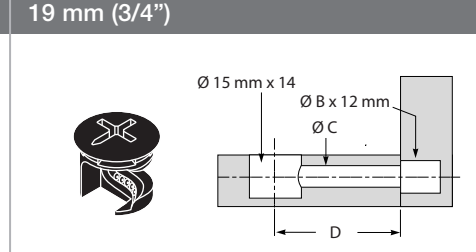

For 3/4" Panels
19mm Panel Thickness
ORDER NUMBER
Zinc Finish 19-232

Dowel Fittings

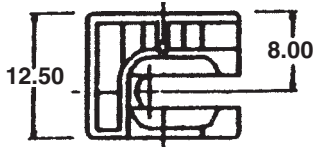
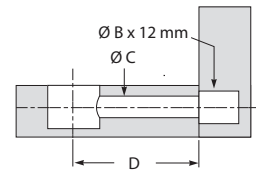

For 5/8" Panels
16mm Panel Thickness
ORDER NUMBER
Zinc finish 19-230

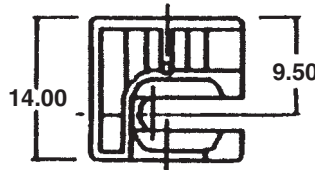

For 3/4" Panels
19mm Panel Thickness
ORDER NUMBER
Zinc finish 19-232

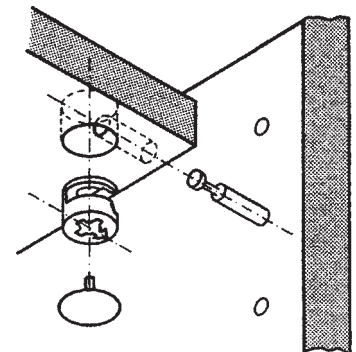

Kitchens

Doors

Kitchen Accessories

Hinges

Drawer Slides

Plywood Melamine

Veneer Edgebanding

Laminate

Solid Surface

Closets

Furniture Hardware

Pulls & Knobs

Lighting

Grommets

Locks, Lock Systems

Molding, Carvings

Tools

Adhesives Solvents Abrasives

Chemicals Staples Screws

Closets

CLOSET RODS AND SOCKETS

ROUND CLOSET ROD

ORDER NUMBER	DIMENSIONS	FINISH
43-812	1" x 8'	Polished Chrome
43-822	1-1/16" x 12'	Chrome on Steel



END SOCKETS

ORDER NUMBER	SOCKET TYPE	SIZE	FINISH
43-268	Closed	1"	Chrome
43-810	Closed	1-1/16"	Chrome
43-270	Open	1-1/16"	Chrome

43-270 Can be used with 1" Rod

OVAL CLOSET ROD

ORDER NUMBER	LENGTH	FINISH
43-694	8'	Nickel
43-712	10'	Nickel

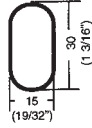

CENTER SUPPORT

ORDER NUMBER	FINISH
43-680	Chrome Plated

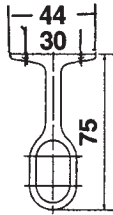

END SOCKETS

ORDER NUMBER	Attachment	FINISH
43-710	Pins for 32mm	Nickel
43-700	Screw-On	Nickel



CABINET HANGING SYSTEM

Features

Adjustable Closet & Kitchen Hanging System

- Sold In Sets Of 2
- Screws And Anchors Included
- Steel Hanging Plate Also Included

TESTING, APRIL 2006

Pull out test strength 115kgs

Compression:

Middle Position of Cabinet – Max 280kgs

Upper Position of Cabinet – Max 200kgs

ORDER NUMBER

59-200

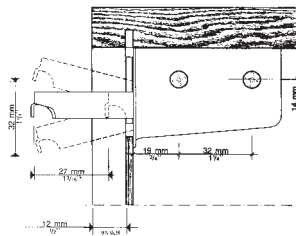

CORNER OVAL TUBE

Chrome Plated Steel
Corner Oval Tube

Order Number **43-372**

Set of 2 supports (**43-374**)
and a central support (**43-376**)
Sold separately

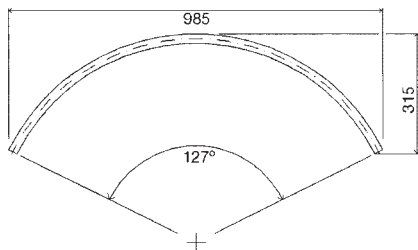
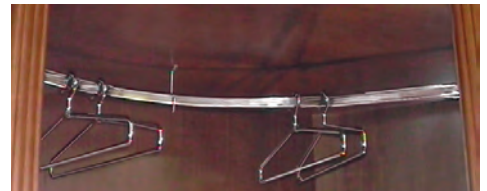

Chrome Plated Steel
Central Support
for Oval Tube
Order Number **43-376**

Chrome Plated Steel
End Support for Oval Tube
Order Number **43-374**

Kitchens

Doors

Kitchen
Accessories

Hinges

Drawer
Slides

Plywood
Melamine

Veneer
Edgebanding

Laminate

Solid
Surface

Closets

Furniture
Hardware

Pulls
&
Knobs

Lighting

Grommets

Locks,
Lock
Systems

Molding,
Carvings

Tools

Adhesives
Solvents
Abrasives

Chemicals
Staples
Screws